



2019 EDITION



FOREST[®]
DRAPERY HARDWARE

The comfort of
ELECTRICALLY
OPERATED
curtains

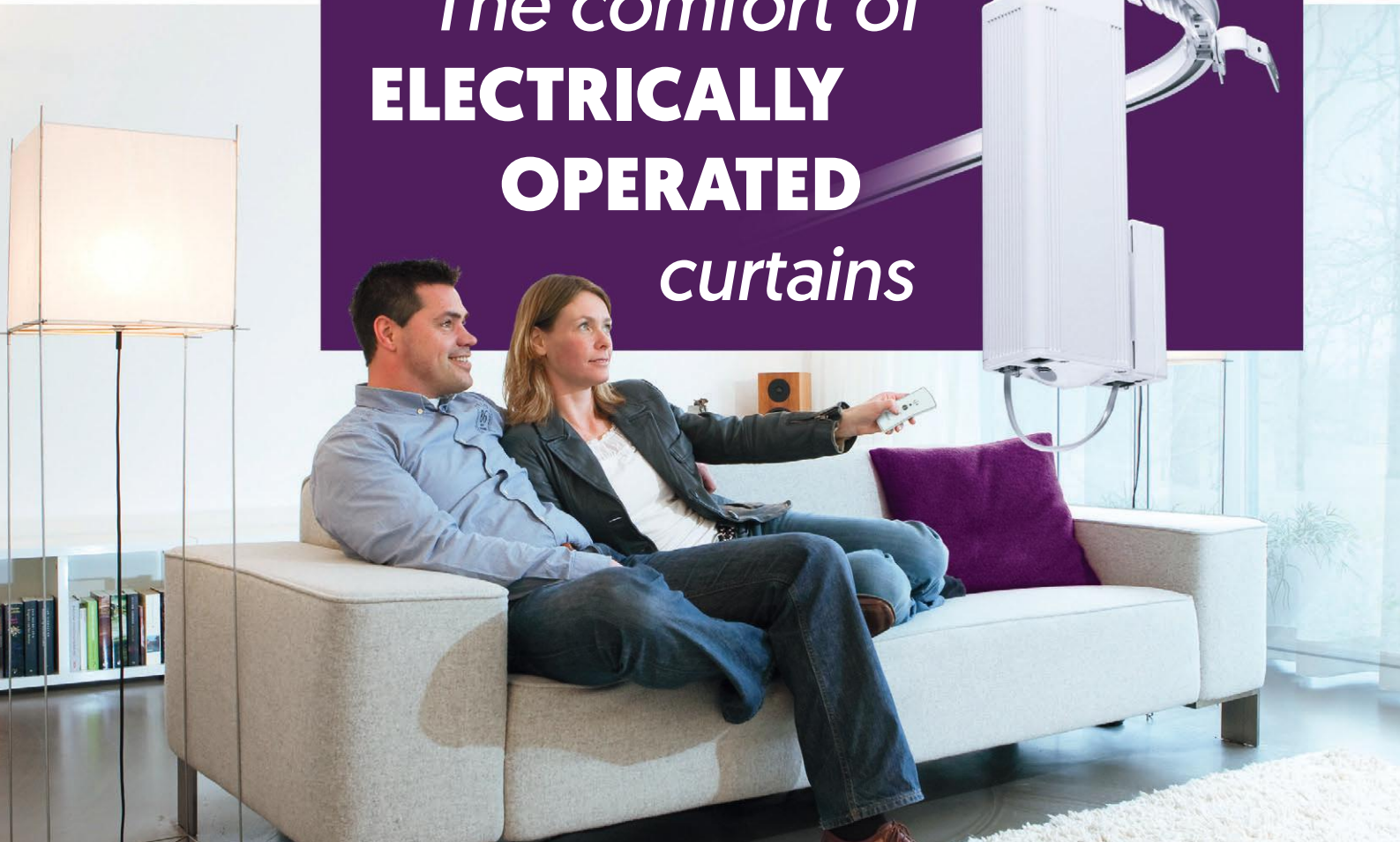



Crown
CURTAIN TRACKS

DISTRIBUTORS FOR
FOREST GROUP (NEDERLAND) B.V.
IN REPUBLIC OF IRELAND

www.crown-curtain-tracks.ie

FOREST DRAPERY HARDWARE – CONTENTS

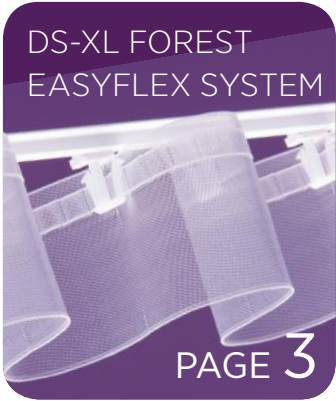
DS-XL FOREST
EASYFLEX SYSTEM



PAGE 3

DS-XL LED FOREST
EASYFLEX SYSTEM



PAGE 4

FMS PLUS
MOTORISED
SYSTEM



PAGE 5

MCS – MULTI
CHANNEL SYSTEM

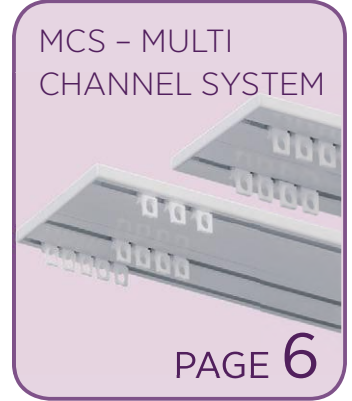

PAGE 6

MRS – MOTORISED
ELECTRIC TRACK SYSTEM

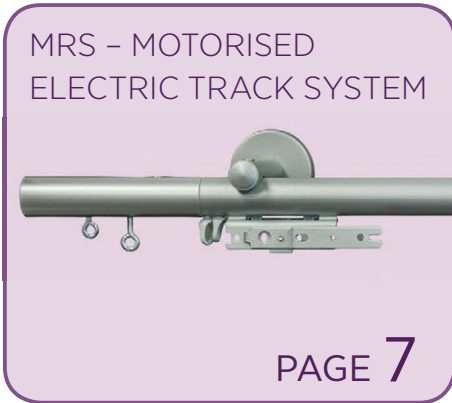

PAGE 7

CRS – 28 MM CORDED &
UNCORDED CHANNEL
ROD SYSTEM



PAGE 8-9

CCS – CORDED CLICK
SYSTEM

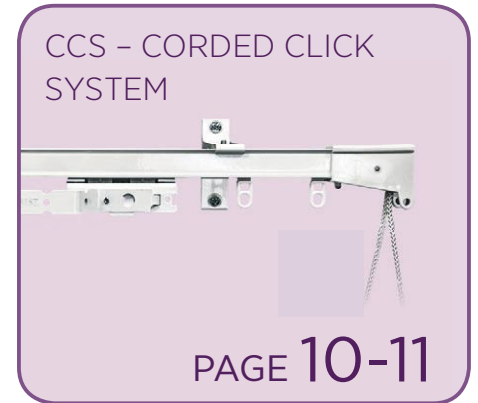

PAGE 10-11

CKS – CORDED
KLICK SYSTEM

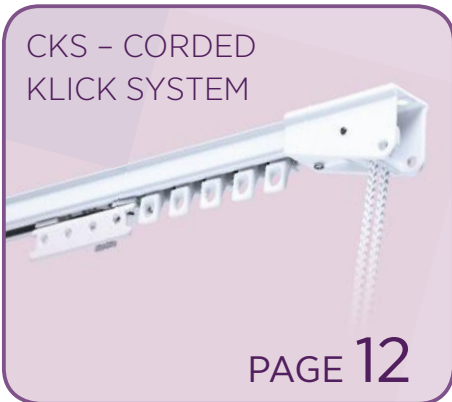

PAGE 12

KS – KLICK SYSTEM



PAGE 13

BS – PREMIER ROMAN
BLIND SYSTEM



PAGE 14

F120 & F400 ALUMINIUM
TRACKS



PAGE 15

SHUTTLE M
& SHUTTLE L
– SILENT
MOTOR, TOUCH
CONTROL
ELECTRIC TRACK

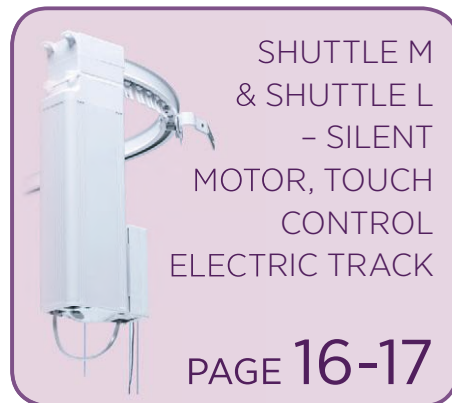

PAGE 16-17

MTS – MEDI TRACK
SYSTEM



PAGE 18

DS-XL

FES – FOREST EASYFLEX SYSTEM

Give a modern and special folding design to your curtains.

The Easyflex systems is an additional feature of the curtain hardware systems. It complies fully with the contemporary demand for round and fluent shapes in decorative interiors. It offers new possibilities for domestic applications in large and high spaces, such as lobbies, entrances, reception areas, conference rooms, auditoriums, meeting rooms, food and beverage outlets etc.

The system can be installed onto all Forest manual, corded and motorised tracks and curtain rod systems (CRS), giving a modern and special folding design to the curtain.

Such a modern curtain heading system combined with a suitable fabric is guaranteed to be a real eye-catcher in any room.



FOREST – DS-XL TOP FIXING TRACK ASSEMBLED PRICES

WIDTH UP TO	DS-XL WHITE TRACK WITH KLICK TOP FIX BRACKET & KS GLIDER	LIST PRICE EX VAT	DSXL TOP FIX RRP INCL. 23% VAT	TOP FIX FIX BRACKET INCLUDED	8CM WAVE EFFECT GLIDER & HOOK	LIST PRICE EXCL. VAT	8CM WAVE GLIDER & HOOK RRP INCL. 23% VAT	LIST PRICE EXCL. VAT	CORDED DS-XL ASSEMBLED RRP INCL. 23% VAT	LIST PRICE EXCL. VAT	CORDED DS-XL 8 CM WAVE GLIDER & HOOK RRP INCL. 23% VAT
100CM	INCLUDING END CAPS & 10 GLIDERS	30.13	37.06	2	16	49.40	60.76	79.99	98.39	99.26	122.09
150CM	INCLUDING END CAPS & 16 GLIDERS	42.34	52.08	3	20	66.42	81.70	90.18	110.92	114.27	140.55
200CM	INCLUDING END CAPS & 20 GLIDERS	54.58	67.13	4	26	85.90	105.66	103.02	126.72	134.34	165.24
250CM	INCLUDING END CAPS & 26 GLIDERS	66.76	82.12	5	34	107.72	132.49	116.43	143.21	157.39	193.59
300CM	INCLUDING END CAPS & 30 GLIDERS	78.87	97.01	6	40	127.04	156.26	129.31	159.05	177.49	218.31
350CM	INCLUDING END CAPS & 36 GLIDERS	91.08	112.03	7	48	148.90	183.14	142.73	175.55	200.55	246.68
400CM	INCLUDING END CAPS & 40 GLIDERS	103.27	127.02	8	52	165.92	204.08	155.58	191.37	218.23	268.42
450CM	INCLUDING END CAPS & 46 GLIDERS	115.64	142.23	9	60	187.91	231.13	168.99	207.86	241.27	296.76
500CM	INCLUDING END CAPS & 50 GLIDERS	129.63	159.44	10	64	206.73	254.28	181.84	223.66	258.92	318.47
550CM	INCLUDING END CAPS & 56 GLIDERS	139.99	172.18	11	72	226.71	278.86	195.29	240.20	282.01	346.88
600CM	INCLUDING END CAPS & 60 GLIDERS	152.17	187.17	12	80	248.54	305.70	208.14	256.02	304.51	374.55

3918301000	DSXL	KLICK CEILING BRACKET	1.23	1.51	EACH
1010001000	KS	OFFSET CARRIER/GLIDER	0.31	0.38	EACH
F4810700016	100M	FLEXI WAVE TAPE	2.19	2.70	PER METER
CRS28650		WALL SUPPORT BARREL BRACKET	23.02	28.32	EACH

DS-XL LED

FES – FOREST EASYFLEX SYSTEM



This unique drapery system combines a stylish design with a unique way of lighting.

DS XL® LED has been designed in such a way that it can be installed without any visible brackets; installation can be done by click or swivel brackets. Thanks to its clever electronic connection, no electrician is required.

CONTROL OPTIONS

This track is a flexible, modular system that enables you to connect with a remote or/and building automation systems. With the remote you can control the amount of light and you have the possibility to illuminate the backside and/or the curtain track itself.

THE DESIGN

The DS XL® LED is an elegant system for all types of medium weight draperies. Available length up to 6 meter. Opt for a regular pleated heading or choose for a more dramatic effect for our wave system Forest Easyflex®

PRODUCT INFORMATION

- Specially designed for Forest Easyfold application.
- Easy installation, only connectors.
- Ceiling brackets and wall bracket available.
- One led strip or two led strips for extra luminosity.
- Low energy consuming led strip,eco friendly.
- Dimmable led strips.
- Lifespan of 30.000 hours.
- No soldering, clickable components for easy installation without the need for an electrician.
- Power: 15 watt/mtr (4.6 Watt/ft)
- Control by Häfele RF remote, home automation or building management system.

FOR USE IN

Domestic and contract market.

SPECIFICATIONS TRACK

- Weight 580 gr/mtr (6.26 ounce/ft)
- Aluminium extrusion.
- Size 60 x 20 mm (2.4 x 0.8 inch)

FOREST – DS-XL LED TOP FIX MANUAL OPERATION

CODE FOREST	LENGTH TRACK (PER METRE)	STANDARD GLIDERS LIST PRICE EX VAT	STANDARD GLIDERS RRP INCL 23% VAT	8CM WAVE EFFECT GLIDERS & HOOKS LIST PRICE EX VAT	8CM WAVE GLIDERS & HOOKS RRP INCL 23% VAT
3922201100	0,00 - 1,00	308.14	379.01	314.30	454.82
3922201150	1,01 - 1,50	389.25	478.78	467.10	574.54
3922201200	1,51 - 2,00	429.78	528.63	515.73	634.35
3922201250	2,01 - 2,50	508.68	625.68	610.41	750.82
3922201300	2,51 - 3,00	551.41	678.23	661.70	813.88
3922201350	3,01 - 3,50	628.53	773.09	754.23	927.71
3922201400	3,51 - 4,00	809.65	995.87	971.59	1,195.04
3922201450	4,01 - 4,50	884.58	1,088.03	1,061.49	1,305.64
3922201500	4,51 - 5,00	931.27	1,145.46	1,117.53	1,374.56
3922201550	5,01 - 5,50	1,003.99	1,234.91	1,204.79	1,481.90
3922201600	5,51 - 6,00	1,051.13	1,292.89	1,261.35	1,551.46

CODE FOREST	LENGTH TRACK (PER METRE)	STANDARD GLIDERS LIST PRICE EX VAT	STANDARD GLIDERS RRP INCL 23% VAT
SURCHARGE FOR REMOTE CONTROL OPERATION			
5917532460	4 - Channel RF Receiver	106.65	131.17
5917502420	Connection Cable 200cm	10.45	12.86
5917532404	4 Channell Remote Control	66.21	81.43
BASED ON:			
1) Single LED strip per track, choose between centre or back placement.			
2) Regular rotating carriers.			





















FMS PLUS

FOREST MOTORISED SYSTEM



FMS PLUS – Shuttle Electric Curtain Track for Recessing into Ceilings

PRODUCT INFORMATION

FMS PLUS TRACK  Aluminium extrusion Available length: 7 m (23") White Black 5/bundle 5131001700 5131006700	FMS PLUS TRANSPORT BELT  Toothed belt to be installed inside FMS Plus Track 100 mtr/roll 5135501000	FMS PLUS RECESS COVEPLATE UPSIDE DOWN  Coveplate for recess; motor pulley White 1/box 5133011004	FMS PLUS / KS TRACK CONNECTORPIN  Stainless steel, 2 x 20 mm For a firm seamless connection 50/box 9900000012
FMS PLUS L-PULLEY  To create a double overlapping track system in combination with only one motor. White 1/box 5133011101	FMS PLUS MASTER CARRIER UNDERLAP  Arm is reversible White Black 10/box 5135801000 5135806000	FMS PLUS RECESS PROFILE  Pre-drilled Combine with fixing strip White 7 mtr (23") 5002001701	FMS PLUS RECESS TRACK  Preshaped 90 degrees curve for FMS plus track 1/box 5133011790
FMS PLUS MOTOR PULLEY  Connects motor with FMS PLUS track White Black 1/box 5133011000 5133016000	FMS PLUS MASTER CARRIER OVERLAP  Arm is reversible White Black 10/box 5135901000 5135906000	FMS PLUS RECESS PROFILE FIXING STRIP  Combine with profile White 6 mtr (20") 5131001600	FMS PLUS RECESS COVERPLATE  Coverplate for recess; motor and return pulley White 1/box 5133011104
FMS PLUS RETURN PULLEY  Reverses the FMS Plus belt in the FMS Plus Track White Black 1/box 5133011100 5133016100	FMS PLUS MASTER CARRIER EASY FLEX L&R  White 10/box 5135901010	FMS PLUS PROFILE WEDGE  To fix the track into the profile 10/box 5131001100	ELECTRIC POWERED BENDER  Available in 230V or 115V, to create continuous curves and arches. Minimum radius 50 cm (20") 1/box 1060500000
FMS PLUS MOTOR PULLEY UPSIDE DOWN  Can be used to place the motor upside down White 1/box 5133011003	ECONOMY CARRIER  Can turn in the track White Black 100/box 2510601000 2510606000	FMS PLUS / MTS TRACK BRIDGE  To join two pieces of track; 6.5 cm White 28 cm White 10/box 4518701000 4518601000	CONTRACT BENDING TOOL  For CS/CS/FMS/CRS/MTS 1/each 2560000000 CS/CS/FMS Bending Wheel Excluding strips 1/each 2561000000 FMS Plus Bending set including strips. 1/each 5131000000

FOREST FMS PLUS 40 KG ELECTRIC TRACK ASSEMBLED PRICES

PRODUCT CODE	WIDTH CM	GLIDER INCL.	WALL BRKT INCL.	40KG MAX WEIGHT FACE FIXING PRICES	LIST PRICE EXCL. VAT	FMS PLUS ASSEMBLED RRP INCL. 23% VAT	8cm WAVE EFFECT GLIDER & HOOK	LIST PRICE EXCLUDING VAT	8CM WAVE GLIDER & HOOK RRP INCL. 23% VAT	6cm WAVE EFFECT GLIDER & HOOK	LIST PRICE EXCL. VAT	6CM WAVE GLIDER & HOOK RRP INCL. 23% VAT
FMS	1-100	10	2	TOP or FACE FIX	983.08	1,209.19	16	1,006.78	1,238.34	24	1,018.64	1,252.92
FMS	101- 200	20	4	TOP or FACE FIX	1,040.06	1,279.28	28	1,081.54	1,330.29	36	1,093.40	1,344.88
FMS	201-300	30	5	TOP or FACE FIX	1,092.31	1,343.55	40	1,151.56	1,416.42	52	1,169.35	1,438.30
FMS	301-400	40	6	TOP or FACE FIX	1,149.28	1,413.61	52	1,226.32	1,508.38	68	1,250.04	1,537.55
FMS	401-500	50	8	TOP or FACE FIX	1,201.51	1,477.86	64	1,296.36	1,594.52	84	1,325.99	1,630.97
FMS	501-600	60	10	TOP or FACE FIX	1,258.50	1,547.95	80	1,377.06	1,693.78	104	1,412.62	1,737.52
BENDING CHARGE FOR FOREST FMS PLUS				PER TRACK	162.60	200.00	PER BEND INCLUDING RECESS PRE BENT 90 PIECE					
F4810700016 100M FLEXI WAVE TAPE				PER METER	2.19	2.70	PER METER					

COMPLETE WITH REMOTE CONTROL & WIRELESS WALL SWITCH

MCS – MULTI CHANNEL SYSTEM

ASYMETRIC REVERSIBLE MULTI CHANNEL SYSTEM TRACK 2/3 GLIDE

PRODUCT INFORMATION

- Asymmetric Reversible Multi Channel System, for use as a 3 or 2 channel track.
- Profile thickness only 8 mm
- Easy installation thanks to 4,5 mm pre-drilled holes. For countersunk installation, 10mm cover caps also available. A profile version without pre-drilled holes is also available
- Available in white, inox-pc and anthracite
- KS components can be used
- Forest Easyfold (FES) also applicable
- Max fabric weight 15 kg per running meter of track

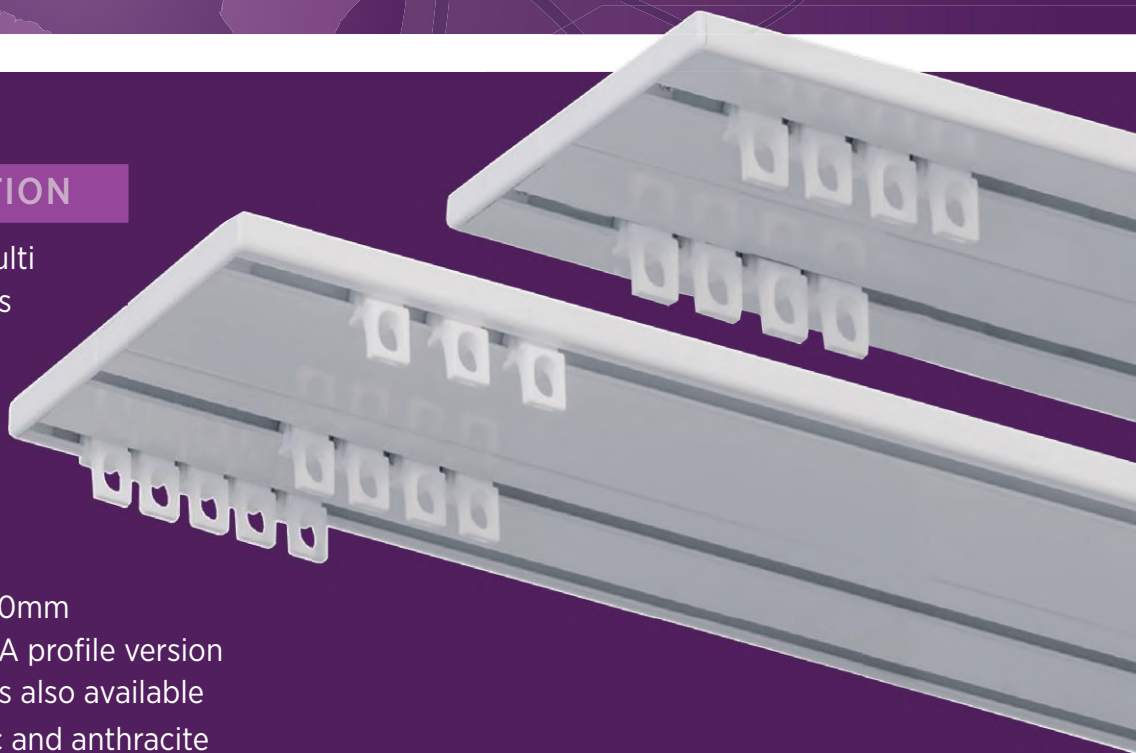

PROFILE

- Aluminium extrusion, powder coated, lubricated. Available in 6 meter length.
- One side of the profile has 3 channels, asymmetrically placed, to accommodate for a full sheer curtain, and two separate blackout curtains; these blackout curtains can overlap each other to prevent light leakage. The wider the fabric panels, the bigger the overlap will become.
- The other side of the profile has 2 channels, symmetrically placed, to accommodate for a sheer and blackout curtain in a traditional set-up.

MCS 2/3 GLIDE PELMET PROFILE

A specially developed pelmet profile, aluminium extrusion, which can be placed on top of the MCS track during installation and secured in place. The perfect solution if no separate pelmet or curtain box has been foreseen.

BLACKOUT PROFILE

The ideal solution to create a perfect blackout on the side of each curtain. The Velcro Hotel Profile is suitable for any Forest curtain rail system. The L shaped profile comes with pre-drilled holes every 50 cm, allowing for an easy fixation on the sides of the window. When the curtain hems are lined with Velcro loop tape, the curtain can be easily fixed against the profiles, eliminating light leakage.

FOREST – MCS MULTI CHANNEL SYSTEM PRICES

PRODUCT CODE	WIDTH	GLIDES INCLUDED	BRACKETS	LIST PRICE EX VAT	2 CHANNEL, RRP INC. VAT	PRODUCT CODE	WIDTH	GLIDES INCLUDED	BRACKETS	LIST PRICE EX VAT	2 CHANNEL, RRP INC. VAT
2 CHANNEL SIDE						3 CHANNEL SIDE					
MCS 200/2	200 cm	40	nil	85.36	105	MCS 200/3	200 cm	60	nil	93.50	115
MCS 400/2	400 cm	80	nil	170.73	210	MCS 400/3	400 cm	120	nil	186.99	230
MCS 600/2	600 cm	120	nil	256.10	315	MCS 600/3	600 cm	180	nil	280.49	345

MRS – MOTORISED ELECTRIC TRACK SYSTEM

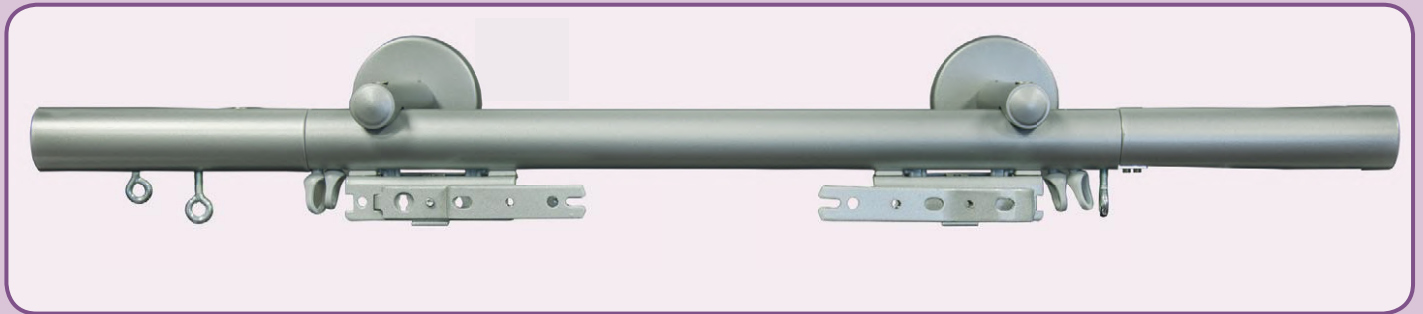

INOX NATURAL



Also available to order in



ANTHRACITE-PC



ANTIQUÉ-PC

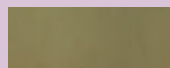

GOLD-PC



INOX-PC

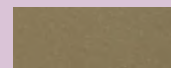

TAUPE-PC



WHITE-PC

MRS MOTORISED 40KG ELECTRIC TRACK ASSEMBLED PRICES

PRODUCT CODE	WIDTH CM	GLIDER INCLUDED	WALL BRKT INCLUDED	40KG MAX WEIGHT FACE FIXING PRICES	LIST PRICE EXCL. VAT	MRS ASSEMBLED RRP INCL. 23% VAT	8cm WAVE EFFECT GLIDER & HOOK	LIST PRICE EXCL. VAT	8CM WAVE GLIDER & HOOK RRP INCL.23% VAT	6cm WAVE EFFECT GLIDER & HOOK	LIST PRICE EXCL. VAT	6CM WAVE GLIDER & HOOK RRP INCL.23% VAT
FMS	1-100	10	2	TOP or FACE FIX	1,118.95	1,376.31	16	1,145.93	1,409.49	24	1159.43	1,426.10
FMS	101- 200	20	4	TOP or FACE FIX	1,183.81	1,456.09	28	1,231.03	1,514.16	36	1244.52	1,530.76
FMS	201-300	30	5	TOP or FACE FIX	1,243.28	1,529.24	40	1,310.72	1,612.18	52	1330.97	1,637.09
FMS	301-400	40	6	TOP or FACE FIX	1,308.12	1,608.99	52	1,395.81	1,716.85	68	1422.81	1,750.06
FMS	401-500	50	8	TOP or FACE FIX	1,367.58	1,682.13	64	1,475.53	1,814.90	84	1509.26	1,856.39
FMS	501-600	60	10	TOP or FACE FIX	1,432.44	1,761.90	80	1,567.38	1,927.88	104	1607.86	1,977.67
FMSB	BENDING CHARGE FOR FOREST MRS BENDING CHARGE TRACK			PER BEND	67.63	83.18	PER BEND	COMPLETE WITH REMOTE CONTROL				
	MRS BENDING CONTINUOUS CURVE			PER TRACK	162.60	200.00	PER TRACK					
CRS28650	SUPPORT BARREL BRACKET Add Extra Bracket for Bay Tracks				23.02	28.32						
F4810700016	100M FLEXI WAVE TAPE			PER METER	2.19	2.70	PER METER	& WIRELESS WALL SWITCH				

CRS – 28 MM CORDED CHANNEL ROD SYSTEM



INOX NATURAL



TAUPE-PC BAY TRACK

Also available to order in



ANTHRACITE-PC

BRONZE



GOLD-PC

INOX-PC



TAUPE-PC

WHITE-PC

FOREST CRS 28mm CORDED TRACK ASSEMBLED PRICES

FACE FIXING PRICES								
PRODUCT CODE	WIDTH, CM	GLIDER INCL.	BRACKET INCL.	LIST PRICE, EXCL. VAT	CRS 28MM ASSEMBLED RRP, INCL. 23% VAT	8CM WAVE EFFECT GLIDER & HOOK	LIST PRICE, EXCL. VAT	8CM WAVE GLIDER & HOOK RRP, INCL. 23% VAT
FCRS28125	125cm	12	2	150.96	185.68	18	179.15	220.35
FCRS28150	150cm	16	2	172.67	212.38	20	203.98	250.90
FCRS28200	200cm	20	2	216.11	265.82	26	256.82	315.89
FCRS28250	250cm	26	3	258.48	317.93	34	311.73	383.43
FCRS28300	300cm	30	3	313.30	385.35	40	375.94	462.41
FCRS28350	350cm	36	3	354.65	436.22	48	429.82	528.68
FCRS28400	400cm	40	4	397.05	488.38	52	478.48	588.53
FCRS28450	450cm	46	5	428.64	527.23	60	522.61	642.81
FCRS28500	500cm	50	5	452.88	557.04	64	553.10	680.31
FCRS28550	550cm	56	6	518.02	637.16	72	630.76	775.84
FCRS28580	580cm	58	6	549.79	676.25	80	675.07	830.34
CRS28BEND	CRS 28MM BENDING ONE BEND			61.50	75.65	PER BEND		
F4810700016	100m FLEXI WAVE TAPE			2.19	2.70	PER METER		
CRS28650	SUPPORT BARREL BRACKET Add Extra Bracket for Bay Tracks			23.02	28.32	EACH		
CRS28650D20	DOUBLE BRACKET 20CM			31.40	38.63	EACH		
CRS CONTINUOUS CURVE CHARGE				162.60	200			

TOP FIXING PRICES							
BRACKET INCL.	WIDTH, CM	LIST PRICE, EXCL. VAT	CRS 28MM ASSEMBLED RRP, INCL. 23% VAT	8CM WAVE EFFECT GLIDER & HOOK	LIST PRICE, EXCL. VAT	8CM WAVE GLIDER & HOOK RRP, INCL. 23% VAT	
2	125	104.91	129.04	18	136.38	167.75	
2	150	126.62	155.74	20	164.60	202.46	
2	200	170.06	209.18	26	221.08	271.93	
3	250	189.40	232.97	34	246.23	302.86	
3	300	244.22	300.39	40	317.48	390.51	
3	350	285.58	351.26	48	371.25	456.64	
4	400	304.96	375.10	52	396.45	487.63	
5	450	313.52	385.63	60	407.58	501.32	
5	500	337.76	415.44	64	439.08	540.07	
6	550	379.87	467.24	72	493.83	607.41	
7	580	411.65	506.33	80	535.14	658.23	
		61.50	75.65	PER BEND			
		2.19	2.70	PER METER			

CRS – 28 MM UNCORDED CHANNEL ROD SYSTEM

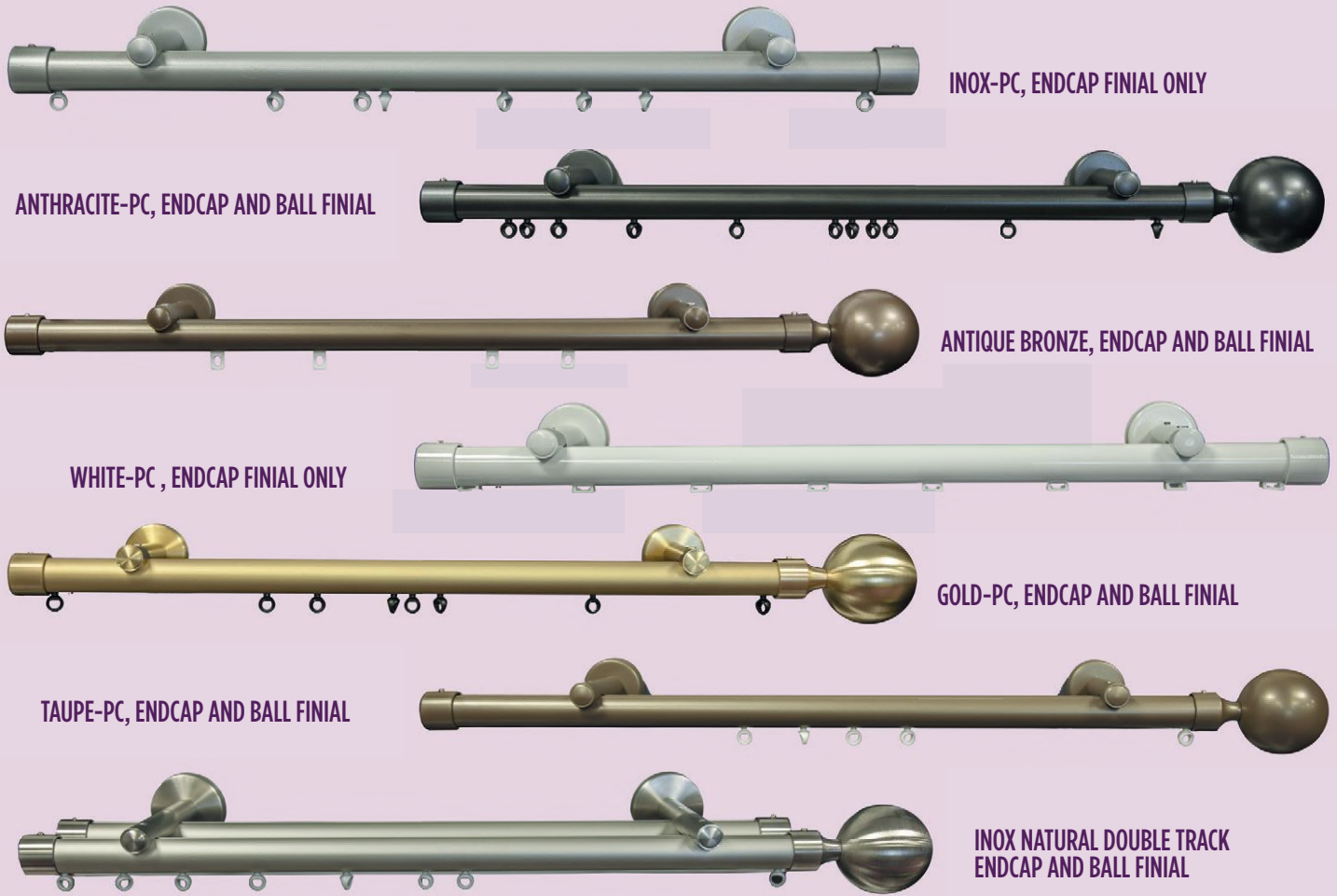

FOREST CRS 28mm UNCORDED TRACK ASSEMBLED PRICES

FACE FIXING PRICES								
PRODUCT CODE	WIDTH, CM	GLIDER INCL.	BRACKET INCL.	LIST PRICE, EXCL. VAT	CRS 28MM ASSEMBLED RRP, INCL. 23% VAT	8CM WAVE EFFECT GLIDER & HOOK	LIST PRICE, EXCL. VAT	8CM WAVE GLIDER & HOOK RRP, INCL. 23% VAT
FCRS28125	125cm	12	2	116.12	142.83	18	137.80	169.50
FCRS28150	150cm	16	2	132.82	163.37	20	156.91	193.00
FCRS28200	200cm	20	2	166.24	204.48	26	197.55	242.99
FCRS28250	250cm	26	3	198.83	244.56	34	239.79	294.95
FCRS28300	300cm	30	3	241.00	296.43	40	289.18	355.69
FCRS28350	350cm	36	3	272.81	335.55	48	330.63	406.67
FCRS28400	400cm	40	4	305.43	375.67	52	368.06	452.71
FCRS28450	450cm	46	5	329.72	405.56	60	402.01	494.47
FCRS28500	500cm	50	5	348.37	428.49	64	425.46	523.32
FCRS28550	550cm	56	6	398.48	490.13	72	485.20	596.80
FCRS28580	580cm	58	6	422.92	520.19	80	519.28	638.72
CRS28BEND	CRS 28mm bending ONE BEND			61.50	75.65	PER BEND		
F4810700016	100m FLEXI WAVE TAPE			2.19	2.70	PER METER		
CRS28650	SUPPORT BARREL BRACKET Add Extra Bracket for Bay Tracks			23.02	28.32	EACH		
CRS28650D20	Double Bracket 20cm			31.40	38.63	EACH		
CRS CONTINUOUS CURVE CHARGE				162.60	200.00			

TOP FIXING PRICES							
BRACKET INCL.	WIDTH, CM	LIST PRICE, EXCL. VAT	CRS 28MM ASSEMBLED RRP, INCL. 23% VAT	8CM WAVE EFFECT GLIDER & HOOK	LIST PRICE, EXCL. VAT	8CM WAVE GLIDER & HOOK RRP, INCL. 23% VAT	
2	125	70.07	86.19	18	93.19	114.63	
2	150	86.77	106.73	20	115.40	141.95	
2	200	120.19	147.84	26	159.85	196.62	
3	250	129.76	159.60	34	172.58	212.27	
3	300	171.93	211.47	40	228.67	281.26	
3	350	203.73	250.59	48	270.96	333.28	
4	400	213.33	262.39	52	283.73	348.99	
5	450	230.08	283.00	60	306.01	376.39	
5	500	241.46	297.00	64	321.15	395.01	
6	550	260.33	320.21	72	346.24	425.87	
6	580	284.77	350.27	80	378.74	465.85	
		61.50	75.65	PER BEND			
		2.19	2.70	PER METER			

CCS – CORDED CLICK SYSTEM

PROFILE

- Weight: 202 grams per metre;
- Aluminium Extrusion 6063 T5;
- Dimensions: 20mm x 20mm.



PRODUCT INFORMATION

- Highly efficient Corded System for all types of medium weight curtains;
- Quick installation with “Smart Klick” brackets for wall and ceiling applications;



Easy installation
click position tighten

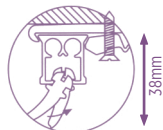

Clickable Carrier

- Bendable; it can be bent and reverse bent using a 10cm radius or continuously curved;
- Heavy duty clickable carriers – UV protected – for smooth and easy traversing. Offset shape for straight hanging pleats;
- Can also be used for Easyflex;
- Maximum fabric weight: 6 kg per metre up to a maximum system weight of 40 kgs;
- Track finish: chromated powder coating with a factory applied patented dry lubricant.

FOR USE IN

Hotels – offices – residences – boats – homes – planes or anywhere an efficient cord traversing system is required.

BENDING/CURVING

The track can be bent and reverse bent using a 10cm radius. Continuous curving can easily be done using the continuous curver. Also the possibility of curving for special windows, such as arches, bows and circles.



MOUNTING BRACKETS

Ceiling Bracket

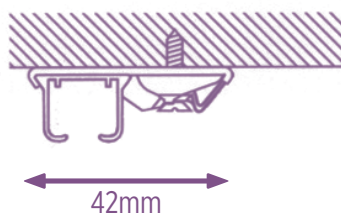

Adjustable Wall Bracket

Smart klick, adjustable single from 7.5cm (3”) to 11.5cm (4.5”)

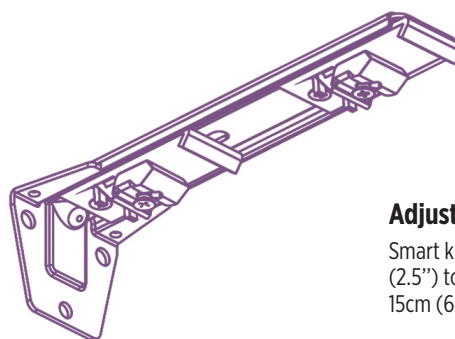
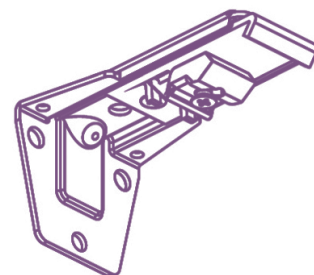

Adjustable Wall Bracket

Smart klick, adjustable double from 6.5cm (2.5”) to 10cm (4”) – 15cm (6”) to 19.5 cm (7.5”)



1. CCS Track
2. CCS/KS Offset Carrier
3. CCS Master Carrier Overlap
4. CCS Master Carrier Underlap
5. CCS Pulley

APPLICATIONS

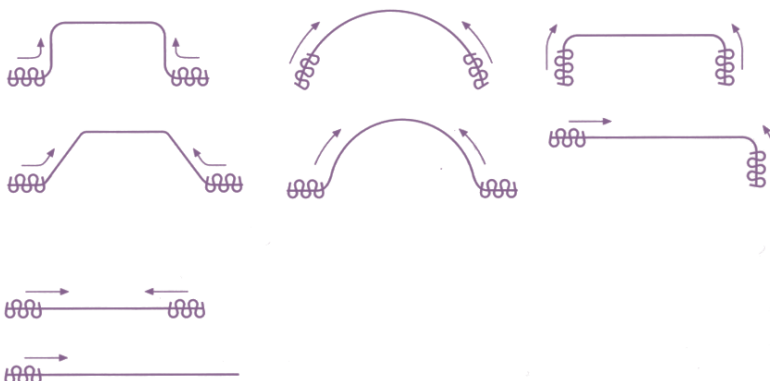

CCS CORDED KLIK SYSTEM AVAILABLE WITH EASYFLEX SYSTEM

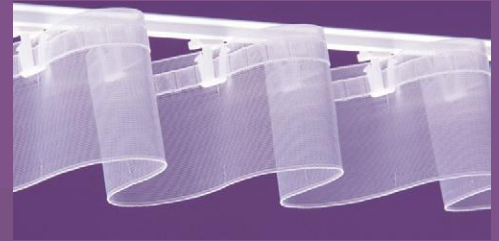

FOREST – CCS CORDED TRACK SYSTEM ASSEMBLED PRICES

PRODUCT CODE	WIDTH CM	CORD DROP	GLIDER INCLUDED	BRACKETS INCLUDED	LIST PRICE EXCL. VAT	CCS ASSEMBLED RRP INCL. 23% VAT	8cm WAVE EFFECT GLIDER & HOOK	LIST PRICE EXCL. VAT	8CM WAVE GLIDER & HOOK RRP INCL. 23% VAT	6cm WAVE EFFECT GLIDER & HOOK	LIST PRICE EXCLUDING VAT	6CM WAVE GLIDER & HOOK RRP INCL. 23% VAT
FCCS100	100CM	1.5M	10	3	99.98	122.98	16	124.07	152.61	20	130.11	160.03
FCCS150	150CM	1.5M	16	4	112.72	138.65	20	142.84	175.69	28	154.88	190.50
FCCS200	200CM	1.5M	20	4	128.78	158.40	26	167.93	206.56	36	182.99	225.08
FCCS250	250CM	1.5M	26	4	145.54	179.01	34	196.74	241.99	44	211.80	260.51
FCCS300	300CM	1.5M	30	5	161.63	198.80	40	221.85	272.88	52	239.93	295.11
FCCS350	350CM	1.5M	36	5	178.41	219.44	48	250.69	308.35	60	268.77	330.58
FCCS400	400CM	1.5M	40	5	194.48	239.22	52	272.79	335.53	68	296.88	365.16
FCCS450	450CM	1.5M	46	6	211.24	259.83	60	301.59	370.96	76	325.68	400.58
FCCS500	500CM	1.5M	50	6	227.29	279.57	64	323.66	398.10	84	353.76	435.13
FCCS550	550CM	1.5M	56	7	244.11	300.26	72	352.52	433.60	96	388.66	478.05
FCCS600	600CM	1.5M	60	8	260.18	320.02	80	380.64	468.18	104	416.77	512.63

FCCSBEND	CCS BENDING ONE BEND		PER BEND	45.78	56.31	PER BEND						
FCCSCB	CCS CONTINUOUS CURVE CHARGE		PER TRACK	162.60	200.00	PER TRACK						
1020801115	SMART KLIK ADJUSTABLE BRACKET		7.5-11.5 CM	7.48	9.20	EACH						
1018201001	KS/CCS/FMS SMART KLIK CEILING BRACKET			2.15	2.65	EACH						
1010001000	KS/CCS/FMS OFFSET CARRIER/GLIDER			0.39	0.48	EACH						
1018401010	KS/CCS TRACK CONNECTOR			9.91	12.19	EACH						
F4810700016	100M FLEXI WAVE TAPE		PER METER	2.19	2.70	PER METER						

CKS – CORDED KLICK SYSTEM

CKS CORDED KLICK SYSTEM
AVAILABLE WITH EASYFLEX
SYSTEM



FOREST – CKS CORDED TRACK SYSTEM ASSEMBLED PRICES

PRODUCT CODE	WIDTH CM	CORD DROP	GLIDER INCLUDED	BRACKETS INCLUDED	LIST PRICE EXCL. VAT	CKS ASSEMBLED RRP INCL. 23% VAT	8cm WAVE EFFECT GLIDER & HOOK	LIST PRICE EXCL. VAT	8CM WAVE GLIDER & HOOK RRP INC 23% VAT	6cm WAVE EFFECT GLIDER & HOOK	LIST PRICE EXCL. VAT	6CM WAVE GLIDER & HOOK RRP INC 23% VAT
FCKS100	100CM	1.5M	10	3	79.99	98.39	16	99.26	122.09	20	104.08	128.02
FCKS150	150CM	1.5M	16	4	90.18	110.92	20	114.27	140.55	28	123.91	152.41
FCKS200	200CM	1.5M	20	4	103.02	126.72	26	134.34	165.24	36	146.39	180.06
FCKS250	250CM	1.5M	26	4	116.43	143.21	34	157.39	193.59	44	169.44	208.41
FCKS300	300CM	1.5M	30	5	129.31	159.05	40	177.49	218.31	52	191.94	236.09
FCKS350	350CM	1.5M	36	5	142.73	175.55	48	200.55	246.68	60	215.01	264.47
FCKS400	400CM	1.5M	40	5	155.58	191.37	52	218.23	268.42	68	237.50	292.12
FCKS450	450CM	1.5M	46	6	168.99	207.86	60	241.27	296.76	76	260.55	320.48
FCKS500	500CM	1.5M	50	6	181.84	223.66	64	258.92	318.47	84	283.00	348.09
FCKS550	550CM	1.5M	56	7	195.29	240.20	72	282.01	346.88	96	310.94	382.45
FCKS600	600CM	1.5M	60	8	208.14	256.02	80	304.51	374.55	104	333.41	410.10

FCKSBEND	CKS BENDING ONE BEND	PER BEND	36.63	45.05	PER BEND							
FCKSCB	CKS CONTINUOUS CURVE CHARGE	PER TRACK	162.60	200.00	PER TRACK							
1020801115	SMART KLICK ADJUSTABLE BRACKET	7.5-11.5 CM	7.48	9.20	EACH							
1018201001	KS/CKS/FMS SMART KLICK CEILING BRACKET		2.15	2.65	EACH							
1010001000	KS/CKS/FMS OFFSET CARRIER/GLIDER		0.31	0.38	EACH							
1018401010	KS/CKS TRACK CONNECTOR		7.93	9.76	EACH							
F4810700016	100M FLEXI WAVE TAPE	PER METER	2.19	2.70	PER METER							

KS KLIK SYSTEM
AVAILABLE WITH
EASYFLEX SYSTEM

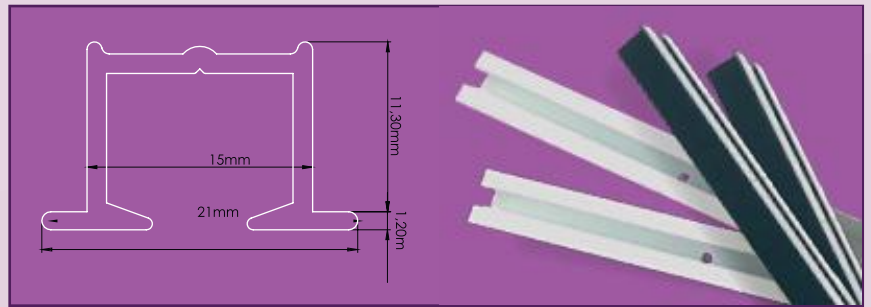

KS Recess Track
Price on request



Also available to order in



FOREST KS UNCORDED TRACK SYSTEM ASSEMBLED PRICES

PRODUCT CODE	WIDTH CM	GLIDER INCLUDED	BRACKETS INCLUDED	LIST PRICE EXCL. VAT	KS ASSEMBLED RRP INCL. 23% VAT	8cm WAVE EFFECT GLIDER & HOOK	LIST PRICE EXCL. VAT	8CM WAVE GLIDER & HOOK RRP INC 23% VAT	6cm WAVE EFFECT GLIDER & HOOK	LIST PRICE EXCL. VAT	6CM WAVE GLIDER & HOOK RRP INC 23% VAT
FKS100	100CM	10	3	38.44	47.28	16	57.71	70.98	20	62.52	76.90
FKS150	150CM	16	4	46.93	57.72	20	71.02	87.35	28	80.66	99.21
FKS200	200CM	20	4	59.66	73.38	26	90.98	111.91	36	103.02	126.72
FKS250	250CM	26	4	72.64	89.34	34	113.59	139.71	44	125.64	154.54
FKS300	300CM	30	5	84.90	104.43	40	133.08	163.68	52	147.53	181.46
FKS350	350CM	36	5	97.94	120.47	48	155.76	191.58	60	170.22	209.37
FKS400	400CM	40	5	110.22	135.57	52	172.85	212.61	68	192.13	236.31
FKS450	450CM	46	6	123.20	151.53	60	195.47	240.43	76	214.74	264.14
FKS500	500CM	50	6	135.45	166.60	64	212.55	261.44	84	236.63	291.06
FKS550	550CM	56	7	148.53	182.69	72	235.25	289.36	96	264.15	324.91
FKS600	600CM	60	8	156.81	192.87	80	253.18	311.42	104	282.09	346.97

FKSBEND	KS BENDING ONE BEND	PER BEND	36.63	45.05	PER BEND						
FKSCB	KS BENDING CONTINUOUS CURVE CHARGE	PER TRACK	162.60	200.00	PER TRACK						
1020801115	SMART KLIK A JUSTABLE BRACKET	7.5-11.5 CM	7.48	9.20	EACH						
1018201001	KS/CKS/FMS SMART KLIK CEILING BRACKET		2.15	2.65	EACH						
1010001000	KS/CKS/FMS OFFSET CARRIER/GLIDER		0.31	0.38	EACH						
1018401010	KS/CKS TRACK CONNECTOR		7.93	9.76	EACH						
F4810700016	100M FLEXI WAVE TAPE	PER METER	2.19	2.70	PER METER						

BS – PREMIER ROMAN BLIND SYSTEM

BS PREMIER CARTRIDGE ROMAN BLIND SYSTEMS – MADE TO MEASURE



Patented Breakaway Control Unit

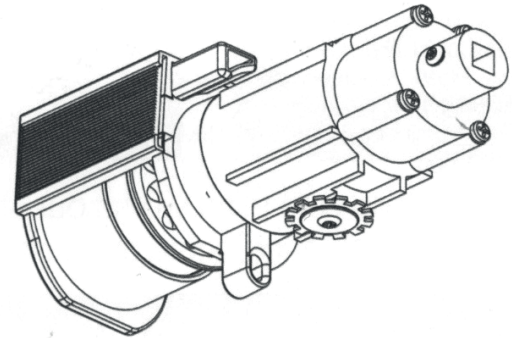

Internal Breakaway Mechanism, 1:4 Control Unit, 7.5kg Lifting Weight Capacity. No Breakaway Devices on the Chain or Drilled Safety Box Needed, Chains can be 60cms from the floor. Patent Approved - Exclusive to Crown Curtain Tracks in R.O.I

CUSTOM MADE TO ORDER – ANY SIZE REQUIRED FROM 32 UP TO 585CMS

- Upgraded 1.2 Gauge Aluminium. Under correct operating conditions these blinds are guaranteed for 10 years;
- Child Safe - Standard 1:4 ratio Control Unit with internal breakaway device. The chain breaks at 6kgs;
- Load Weight is a full 7.5kgs, no visible chain breakers or safety boxes are needed;
- Chains can be 60cms from the floor;
- Fibreglass Rods included;
- Counterweight bars included;
- Price are based on standard universal/ceiling brackets;
- Roman Blinds Tape included

FOREST BS PREMIER ROMAN BLIND SYSTEM – MADE TO MEASURE

Internal Breakaway Chain Wheel – 1:4 Control Unit – Patent Approved. No breakaway devices required on the chain & no chain tensioner required – the chain can be fitted 60cm from the floor. Exclusive to Crown Curtain Tracks Ltd in Ireland.

PRODUCT CODE	WIDTH CM	CHAIN 1M CHROME	CORD 3.5M DRUMS	BRACKETS FACE FIX	FIBRE GLASS RODS	BOTTOM BAR	LIST PRICE EX. VAT	RRP inc 23% VAT
CPRBS	0-50CM	1M	2	2	5	1	44.98	55.33
CPRBS	75CM	1M	2	2	5	1	51.43	63.26
CPRBS	100CM	1M	3	3	5	1	63.78	78.45
CPRBS	125CM	1M	4	4	5	1	70.25	86.40
CPRBS	150CM	1M	4	4	5	1	82.58	101.57
CPRBS	175CM	1M	4	4	5	1	89.03	109.51
CPRBS	200CM	1M	5	5	5	1	95.51	117.48
CPRBS	225CM	1M	5	5	5	1	107.83	132.63
CPRBS	250CM	1M	5	5	5	1	114.29	140.58
CPRBS	275CM	1M	6	6	5	1	126.65	155.78
CPRBS	300CM	1M	6	6	5	1	133.09	163.70
CPRBS	350CM	1M	7	7	5	1	151.89	186.83
CPRBS	400CM	1M	8	8	5	1	170.68	209.94
CPRBS	450CM	1M	9	9	5	1	189.47	233.05
CPRBS	500CM	1M	10	10	5	1	202.40	248.95
CPRBS	585CM	1M	12	12	5	1	236.12	290.42

CHILD SAFE INTERNAL BREAKAWAY CHAIN WHEEL - BREAKS AWAY AT 6KG - LOAD WEIGHT IS 7.5 KG

F120 & F400 ALUMINIUM TRACKS

F120 WHITE OR NATURAL ALUMINIUM TRACK

F120 TRACK 15MM	WIDTH, CM	WHITE OR NATURAL	TRACK COMPLETE	LIST PRICE EX VAT	RRP INC 23% VAT
F120125	125cm	ALUMINIUM TRACK	12 Gliders & 2 brackets	18.53	22.79
F120150	150cm	ALUMINIUM TRACK	16 Gliders & 2 brackets	22.24	27.35
F120175	175cm	ALUMINIUM TRACK	18 Gliders & 3 brackets	25.95	31.91
F120200	200cm	ALUMINIUM TRACK	20 Gliders & 3 brackets	29.66	36.49
F120225	225cm	ALUMINIUM TRACK	22 Gliders & 3 brackets	33.36	41.03
F120250	250cm	ALUMINIUM TRACK	26 Gliders & 4 brackets	37.07	45.60
F120275	275cm	ALUMINIUM TRACK	28 Gliders & 4 brackets	40.79	50.17
F120300	300cm	ALUMINIUM TRACK	30 Gliders & 4 brackets	44.51	54.74
F120325	325cm	ALUMINIUM TRACK	32 Gliders & 5 brackets	48.19	59.28
F120350	350cm	ALUMINIUM TRACK	36 Gliders & 5 brackets	51.70	63.59
F120375	375cm	ALUMINIUM TRACK	38 Gliders & 5 brackets	55.62	68.41
F120400	400CM	ALUMINIUM TRACK	40 Gliders & 6 brackets	59.33	72.97
F120425	425cm	ALUMINIUM TRACK	42 Gliders & 6 brackets	63.03	77.52
F120450	450cm	ALUMINIUM TRACK	46 Gliders & 6 brackets	66.74	82.10
F120475	475cm	ALUMINIUM TRACK	48 Gliders & 7 brackets	70.46	86.67
F120500	500cm	ALUMINIUM TRACK	50 Gliders & 7 brackets	74.17	91.23
F120525	525cm	ALUMINIUM TRACK	52 Gliders & 7 brackets	77.87	95.78
F120550	550cm	ALUMINIUM TRACK	56 Gliders & 8 brackets	81.58	100.34
F120575	575cm	ALUMINIUM TRACK	58 Gliders & 8brackets	85.28	104.90
F120600	600cm	ALUMINIUM TRACK	60 Gliders & 8 brackets	89.68	110.31



F120 White - showing bracket cover



F120 Natural Aluminium



F120 Natural Aluminium



F400 White



F400 White



F120 & F400
Wall Bracket
& Cover

F120 & F400 Ceiling
Bracket
& Cover

F120 & F400 CAN BE BENT FOR BAY WINDOWS

One bend	Bending F120 or F400	Per 30cm or Per FT	10.82	13.30
Two bend	Bending F120 or F400	Per 30cm or Per FT	12.67	15.58
Four bend	Bending F120 or F400	Per 30cm or Per FT	16.22	19.95

F400 WHITE ALUMINIUM TRACK

F400 TRACK 23MM	WIDTH, CM	WHITE TRACK	TRACK COMPLETE	LIST PRICE EX VAT	RRP INC 23% VAT
F400125	125cm	ALUMINIUM TRACK	12 Gliders & 2 brackets	32.41	39.87
F400150	150cm	ALUMINIUM TRACK	16 Gliders & 2 brackets	38.10	46.86
F400175	175cm	ALUMINIUM TRACK	18 Gliders & 3 brackets	43.59	53.62
F400200	200cm	ALUMINIUM TRACK	20 Gliders & 3 brackets	48.87	60.11
F400225	225cm	ALUMINIUM TRACK	22 Gliders & 3 brackets	54.56	67.11
F400250	250cm	ALUMINIUM TRACK	26 Gliders & 4 brackets	59.85	73.62
F400275	275cm	ALUMINIUM TRACK	28 Gliders & 4 brackets	65.54	80.61
F400300	300cm	ALUMINIUM TRACK	30 Gliders & 4 brackets	78.38	96.41
F400325	325cm	ALUMINIUM TRACK	32 Gliders & 5 brackets	83.87	103.16
F400350	350cm	ALUMINIUM TRACK	36 Gliders & 5 brackets	89.16	109.66
F400375	375cm	ALUMINIUM TRACK	38 Gliders & 5 brackets	94.45	116.17
F400400	400cm	ALUMINIUM TRACK	40 Gliders & 6 brackets	100.14	123.17
F400250	425cm	ALUMINIUM TRACK	42 Gliders & 6 brackets	105.81	130.15
F400450	450cm	ALUMINIUM TRACK	46 Gliders & 6 brackets	111.52	137.17
F400475	475cm	ALUMINIUM TRACK	48 Gliders & 7 brackets	116.60	143.41
F400500	500cm	ALUMINIUM TRACK	50 Gliders & 7 brackets	122.48	150.65
F400525	525cm	ALUMINIUM TRACK	52 Gliders & 7 brackets	127.58	156.92
F400550	550cm	ALUMINIUM TRACK	56 Gliders & 8 brackets	133.26	163.91
F400575	575cm	ALUMINIUM TRACK	58 Gliders & 8brackets	138.95	170.90
F400600	600cm	ALUMINIUM TRACK	60 Gliders & 8 brackets	144.64	177.91

SHUTTLE M (70KG)

SILENT MOTOR, TOUCH CONTROL ELECTRIC TRACK

Carry weights of up to 70 kgs



PRODUCT INFORMATION

- Touch Impulse Technology, gently pulling the curtain to open or close (standard feature);
- Integrated Emergency Control ensures manual operation of the curtain in case of power failure;
- Modular motor, different modules can be attached for various control options: radio Frequency, Switch, Infrared, Domotics, Building/hotel automation, Serial communication, Z-wave, etc;
- Silent motor, speed: 15 cm/sec;
- The motor is able to carry weights of up to 70 kgs;
- **Market leading 10 year warranty**
- Full automatic setting of the limits;
- Programming of intermediate positions possible;
- Touch Impulse sensitivity adjustable in 2 positions;
- Stack-back position programmable to every desired setting;
- Touch Impulse function can be switched on and off;

- 24 Volt DC Power Input, by using the 110-240 Volt ac adaptor (white) and Bracket;
- Motor pulley connects motor and FMS track;
- All brackets applicable;
- Upside down inverted motor mounting available;
- Torque: 1.8 Nm;
- Variable velocity with slow start and slow stop;
- Dimensions Motor: 70 x 50 x 235 mm (2.76 x 1.97 x 9.25 inch)
- Dimensions Adaptor: 50 x 110 x 30 mm (1.97 x 4.33 x 1.18 inch)



SHUTTLE M & L AVAILABLE WITH EASYFLEX SYSTEM



FOREST SHUTTLE M 70 KG ELECTRIC TRACK ASSEMBLED PRICES

PRODUCT CODE	WIDTH CM	GLIDER INCL.	WALL BRKT INCL.	70KG MAX WEIGHT FACE FIXING PRICES	LIST PRICE EXCL. VAT	SHUTTLE M ASSEMBLED RRP INCL.23% VAT	8cm WAVE EFFECT GLIDER & HOOK	LIST PRICE EXCL. VAT	8CM WAVE GLIDER & HOOK RRP INC23% VAT	6cm WAVE EFFECT GLIDER & HOOK	LIST PRICE EXCL. VAT	6CM WAVE GLIDER & HOOK RRP INC 23% VAT
FMS	1-100	10	2	TOP or FACE FIX	983.07	1,209.18	18	1,011.99	1,244.74	24	1,011.99	1,244.74
FMS	101- 200	20	4	TOP or FACE FIX	1,040.05	1,279.26	26	1,071.38	1,317.79	36	1,083.43	1,332.61
FMS	201-300	30	5	TOP or FACE FIX	1,092.30	1,343.53	40	1,140.49	1,402.80	52	1,154.95	1,420.59
FMS	301-400	40	6	TOP or FACE FIX	1,149.27	1,413.61	52	1,211.91	1,490.65	68	1,231.19	1,514.36
FMS	401-500	50	8	TOP or FACE FIX	1,201.53	1,477.88	64	1,278.62	1,572.70	84	1,302.71	1,602.34
FMS	501-600	60	10	TOP or FACE FIX	1,237.58	1,522.22	80	1,354.89	1,666.52	104	1,383.81	1,702.08
FMSB	BENDING CHARGE FOR FOREST SHUTTLE TRACK			PER BEND	50.73	62.39	PER BEND					
	SHUTTLE CONTINUOUS CURVE CHARGE			PER TRACK	162.60	200.00	PER TRACK					
F4810700016	100M FLEXI WAVE TAPE			PER METER	2.19	2.70	PER METER					

SHUTTLE L (40KG)

SILENT MOTOR, TOUCH CONTROL ELECTRIC TRACK

Carry weights of up to 40 kgs

SHUTTLE PROFILE

- Weight: 303 gr / mtr (3.25 ounce / ft.)
- Size: 20x20mm (0.79 x 0.79 inch)
- Aluminium Extrusion 6063 T5
- Scale 1:1



BENDING/CURVING

Bends with a radius of 20 cm (8").

30cm (1 ft)

Min 55cm

PRODUCT INFORMATION

- This brand new curtain motor has an integrated power adaptor and only needs a mains cable;
- The RF multi receiver is now integrated in the motor itself, allowing for an even cleaner look of the system;
- The motor speed can be increased by up to 20%, allowing for speeds of up to 18 cm per second;
- The motor is able to carry curtain weights of up to 40 kg;
- **Market leading 10 year warranty**
- Touch Impulse Technology, gently pulling the curtain to open or close (standard feature);
- Integrated Emergency Control ensures manual operation of the curtain in case of power failure;
- Modular motor, different modules can be attached for various control options: radio Frequency, Switch, Infrared, Domotics, Building/hotel automation, Serial communication, Z-wave, etc;
- Silent motor, speed: 15 cm/sec;
- Full automatic setting of the limits;
- Programming of intermediate positions possible;
- Touch Impulse sensitivity adjustable
- in 2 positions;
- Stack-back position programmable to every desired setting;
- Touch Impulse function can be switched on and off;
- 24 Volt DC Power Input, by using the 110- 240 Volt AC adaptor (white) and Bracket;
- Motor pulley connects motor and FMS track;
- All brackets applicable;
- Upside down inverted motor mounting available;
- Torque: 1.8 Nm;
- Variable velocity with slow start and slow stop;
- Dimensions Motor: 70 x 50 x 280 mm (2.76 x 1,97 x 11 inch)



FOREST SHUTTLE L 40 KG ELECTRIC TRACK ASSEMBLED PRICES

PRODUCT CODE	WIDTH CM	GLIDER INCL.	WALL BRKT INCL.	40KG MAX WEIGHT FACE FIXING PRICES	LIST PRICE EXCL. VAT	SHUTTLE L ASSEMBLED RRP INCL. 23% VAT	8cm WAVE EFFECT GLIDER & HOOK	LIST PRICE EXCLUDING VAT	8CM WAVE GLIDER & HOOK RRP INCL. 23% VAT	6cm WAVE EFFECT GLIDER & HOOK	LIST PRICE EXCL. VAT	6CM WAVE GLIDER & HOOK RRP INCL. 23% VAT
FMS	1-100	10	2	TOP or FACE FIX	799.25	983.08	16	818.52	1,006.78	24	828.16	1,018.64
FMS	101- 200	20	4	TOP or FACE FIX	845.58	1,040.06	28	879.30	1,081.54	36	888.94	1,093.40
FMS	201-300	30	5	TOP or FACE FIX	888.06	1,092.31	40	936.23	1,151.56	52	950.69	1,169.35
FMS	301-400	40	6	TOP or FACE FIX	934.37	1,149.28	52	997.01	1,226.32	68	1,016.29	1,250.04
FMS	401-500	50	8	TOP or FACE FIX	976.84	1,201.52	64	1,053.95	1,296.36	84	1,078.04	1,325.99
FMS	501-600	60	10	TOP or FACE FIX	1,023.17	1,258.50	80	1,119.56	1,377.06	104	1,148.47	1,412.62
FMSB	SHUTTLE CONTINUOUS CURVE CHARGE			PER BEND	162.60	200.00	PER BEND					
BENDING CHARGE FOR FOREST SHUTTLE TRACK				PER TRACK	50.73	62.39	PER TRACK					
F4810700016	100M FLEXI WAVE TAPE			PER METER	2.19	2.70	PER METER					

COMPLETE WITH REMOTE CONTROL & WIRELESS WALL SWITCH

MTS – MEDI TRACK SYSTEM

PRODUCT INFORMATION

- Elegant and functional Medical Track System.
- Simple and quick installation.
- Bendable, both with an inside and outside bend with a 20 cm radius.
- Dustproof synthetic insert strip available.
- Bending Tool which can curve tracks easily.
- Colour: White.
- Lengths: 5.80 m (19') and 7 m (23')
- Rail quality: aluminium, chromated, powder coated.
- Factory applied patented dry lubricant.



PROFILE

- Size width: 19,6 mm (0,8") 28 m
- Size high: 30 mm (1,2")
- Shown actual size 1:1
- Aluminium Extrusion
- Weight: 500 grams per meter (5,36 ounce per ft.)

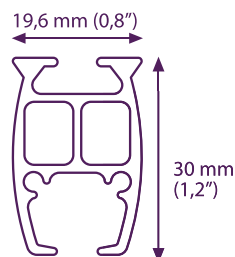

BENDING

The track can be curved and reversed curved in a 20 cm (8") radius. Continuous curving is also available by special order from factory only.



MOUNTING

1. MTS Track
2. MTS Wall Bracket
3. MTS Carrier with Metal Hook
4. MTS Suspension Ceiling Bracket
5. MTS Track Bridge Long
6. MTS End-Cap

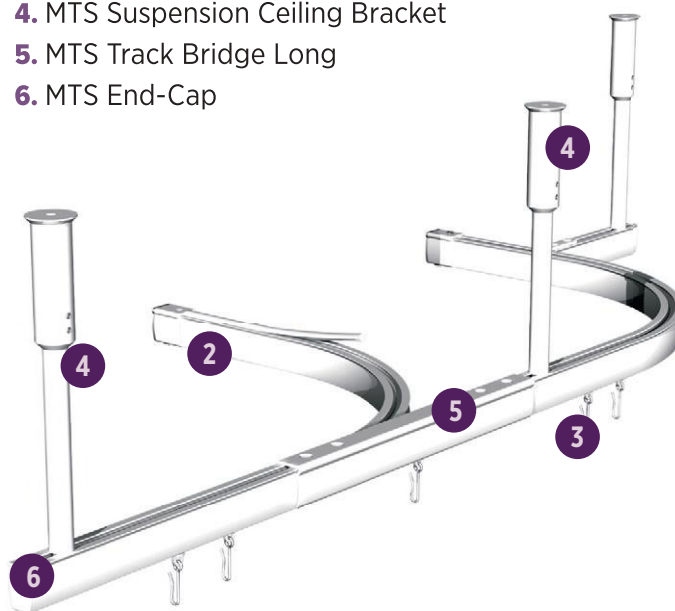

FOREST – MTS MEDI TRACK SYSTEM PRICES

PRODUCT CODE	WIDTH	DESCRIPTION	LIST PRICE EX VAT	RRP INC. VAT	UNIT
4501001580	5.80m	Medi Track System White	72.34	89.01	-
4510001000	Each	CS Economy Guide with Hook	0.57	0.70	Each
4516001000	Each	MTS End Stop with Metal Screw	0.44	0.54	Each
4518201500	1.5m	SUSP Ceiling hanger Complete	41.53	51.07	Each
4518601000	Each	Rail Bridge White Long 28cm	10.98	13.51	Each
4518701000	Each	Rail Bridge White Short 6.5cm	8.70	10.69	Each
4520001000	Each	MS Wall Bracket White	3.19	3.93	Per mtr
Quick Guide	5.80m	Complete 5.8m straight Medi Track	202.04	248.50	Complete
		Cubicle bend charge	34.14	42.00	

This system meets safety requirements in NEN 3134 (Low voltage installations in medical rooms)

FOREST TRACK BENDING

Our fully trained Forest track technicians will bend and shape tracks to your exact specification, all they need is a template to follow or the accurate measurements from one of the diagrams below.

FOREST TRACK DESIGN	MINIMUM RADIUS	REVERSE BEND	POWDER COATED	PATENTED DRY LUBRICANT	COST PER BEND
KS Klick System	10 cm	✓	✓	✓	
CKS Corded Klick System	10 cm	✓	✓	✓	
CS Contract System	20 cm	✓	✓	✓	
CCS Contract Corded System	20 cm	✓	✓	✓	
Shuttle Silent Touch Control Motor	20 cm	✓	✓	✓	
CRS Channel Rod System – 28mm	20 cm	✓	✓ All except Chrome	✓ All except Chrome	

L-SHAPE BAY WINDOW



MEASUREMENTS REQUIRED

A - B =
B - C =
A - C =

L-SHAPE BAY WINDOW WITH 1 REVERSE BEND



MEASUREMENTS REQUIRED

A - B =
B - C =
A - C =
B - D =

SQUARE BAY WINDOW WITH RIGHT ANGLE BENDS

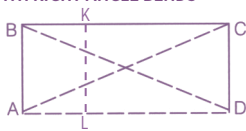

MEASUREMENTS REQUIRED

A - B = B - D =
B - C = A - D =
C - D = K - L =
A - C =

SQUARE BAY WINDOW WITH RIGHT ANGLE BENDS & 2 REVERSE BENDS

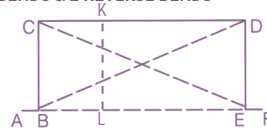

MEASUREMENTS REQUIRED

A - B = E - F =
B - C = B - D =
C - D = B - E =
D - E = C - E =
K - L =

2 BEND ANGLED BAY WINDOW

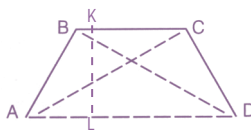

MEASUREMENTS REQUIRED

A - B = B - D =
B - C = A - D =
C - D = K - L =
A - C =

2 BEND ANGLED BAY WINDOW WITH 2 REVERSE BENDS

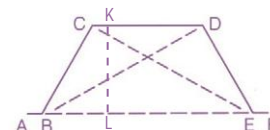

MEASUREMENTS REQUIRED

A - B = E - F =
B - C = B - D =
C - D = B - E =
D - E = C - E =
K - L =

4 BEND BAY WINDOW

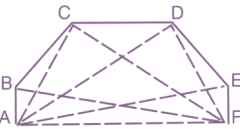

MEASUREMENTS REQUIRED

A - B = A - D =
B - C = A - E =
C - D = B - F =
D - E = C - F =
E - F = A - F =
A - C = D - F =

4 BEND BAY WINDOW WITH 2 REVERSE BENDS

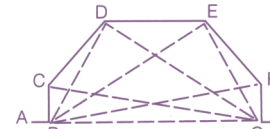

MEASUREMENTS REQUIRED

A - B = G - H =
B - C = B - G =
C - D = B - E =
D - E = C - G =
E - F = D - G =
F - G = E - G =
B - F = B - D =

FOREST TRACK CONTINUOUS CURVING

Our fully trained Forest track technicians will apply continuous curves to your exact specification, all they need is a template to follow or the accurate measurements from one of the diagrams below.

FOREST TRACK DESIGN	MINIMUM RADIUS	REVERSE BEND	POWDER COATED	PATENTED DRY LUBRICANT	COST PER BEND, CONTINUOUS CURVE
KS Klick System	50 cm	✓	✓	✓	
CKS Corded Klick System	50 cm	✓	✓	✓	
CS Contract System	50 cm	✓	✓	✓	
CCS Contract Corded System	50 cm	✓	✓	✓	
Shuttle Silent Touch Control Motor	50 cm	✓	✓	✓	

CONTINUOUS CURVE BAY WINDOW

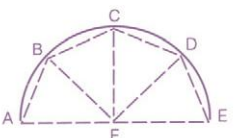

MEASUREMENTS REQUIRED

A - B = F - E =
B - C = F - C =
C - D = B - F =
D - E = D - F =
A - F =

CONTINUOUS CURVE BAY WINDOW WITH 2 REVERSE BENDS

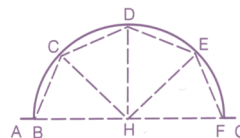

MEASUREMENTS REQUIRED

A - B = B - H =
B - C = H - F =
C - D = H - D =
D - E = H - C =
E - F = H - E =
F - G =

THE BEST GOT BETTER

- + EASY TO BEND
- + PATENTED DESIGN
- + INCREASED STABILITY
- + LIFE-TIME WARRANTY
- + CLICKABLE COMPONENTS
- + SILENT & SMOOTH OPERATION



THE HOTEL TRACKS FOR HEAVY DUTY APPLICATIONS

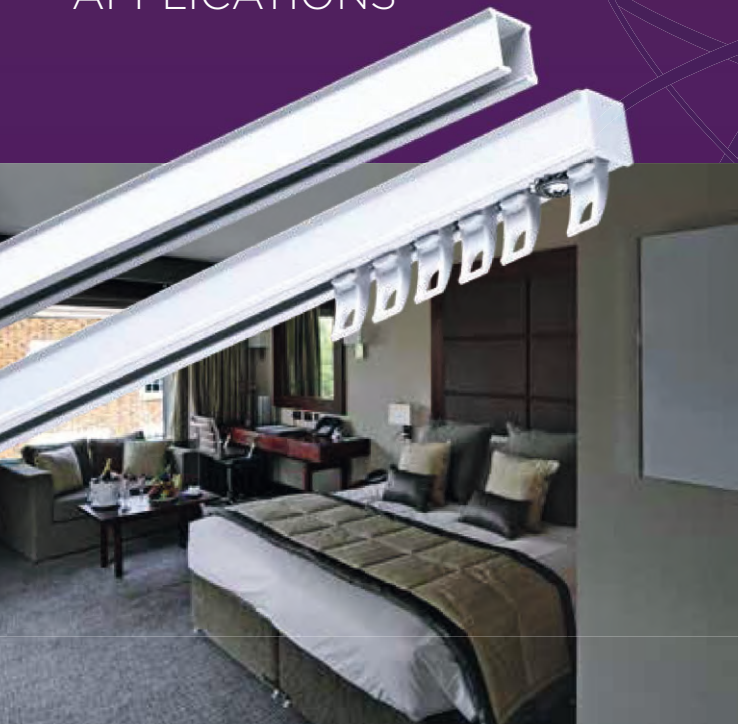

EASYFOLD SYSTEM CONTINUOUS FOLDING DRAPERY



Crown Curtain Tracks Ltd.

Unit 18A JFK Avenue, JFK Industrial Estate,
Naas Road, Dublin 12

Post code D12 KV57

Telephone: +353 (0)1 401 8644 / 401 8648

Fax +353 (0) 1 507 8190

Email: crowncurtaintracks.ie@gmail.com

Web: www.crown-curtain-tracks.ie